

WanTeng®

LED desk lamp

Item: UE-T2243

User's Manual





EN



LED Desk Lamp Specification

Item No	UE-T2243
Cable length	200cm
Color	silver
Package	Color box
Input	AC 100~240V 50/60Hz
Power	LED >3.4 W
luminous flux	>260 Lumens
Luminance	600 Lux (35cm)
Color Temperature	3900~4200K warm white
Protection levels	IP53, indoor use
light source	Panel Lighting LED (DC 10.5V,320mA,3.4W)
Weight	1kg

PLUG STYLE

-  UL USA Canada
-  VDE Europe
-  BS the U.K.
-  SAA Australia

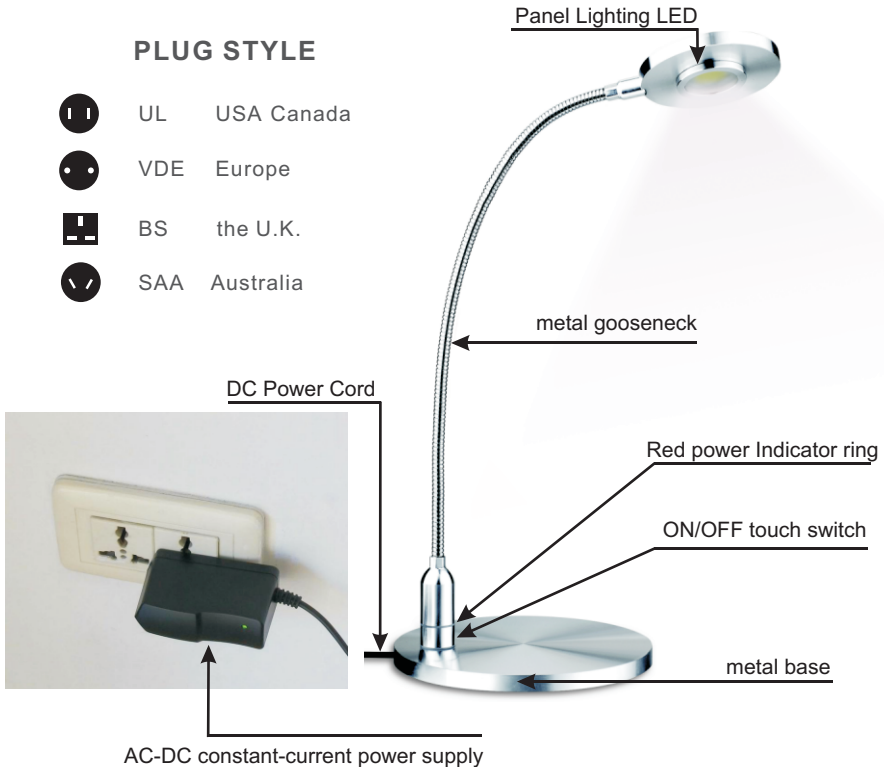

Important Notice

Don't remake & Part replace

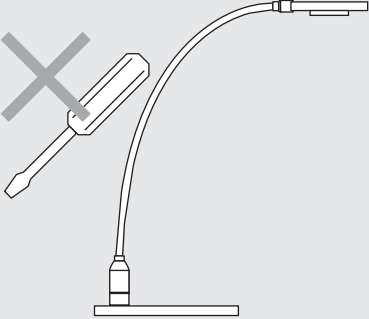

A diagram of a desk lamp with a curved neck. A screwdriver is shown with a large 'X' over it, indicating that the lamp should not be disassembled or have parts replaced.

Pls use the attached special AC-DC adapter

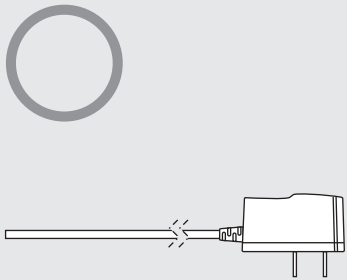

A diagram showing a circular symbol above a lamp. The lamp's power cord is connected to a special AC-DC adapter, indicating that this specific adapter should be used.

Don't sharp object puncture wound

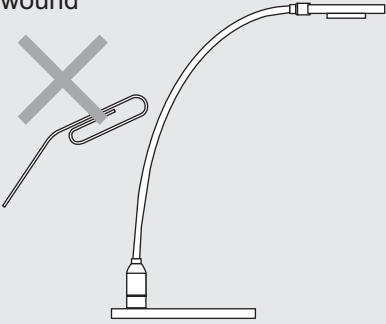

A diagram of a desk lamp with a curved neck. A paperclip is shown with a large 'X' over it, indicating that sharp objects should not be used to puncture or damage the lamp.

Don't use the wet hand or break in Swap plug form socket

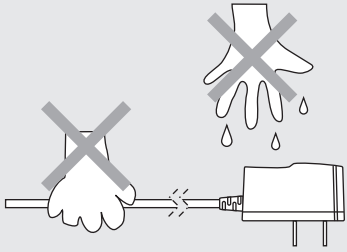

A diagram showing a lamp with a curved neck. A hand is shown with a large 'X' over it, indicating that wet hands should not be used. Another hand is shown plugging a cord into a socket, also with a large 'X' over it, indicating that unsafe plugging should be avoided.

Don't use for outdoor



A diagram showing a desk lamp with a curved neck and a house icon. A large 'X' is placed over the lamp, indicating that the lamp should not be used outdoors.

Don't use heavy object on the any part

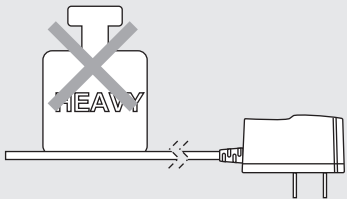

A diagram showing a desk lamp with a curved neck. A heavy object, labeled 'HEAVY', is shown with a large 'X' over it, indicating that heavy objects should not be placed on any part of the lamp.

Tilt rejected, pls horizontal place

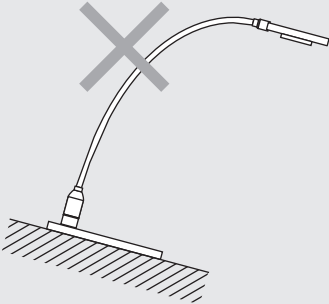

keep the gooseneck camber to smooth

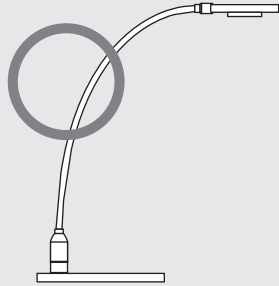

be kept out of heat

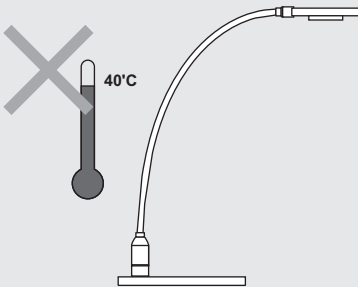

Don't sharp turn for gooseneck

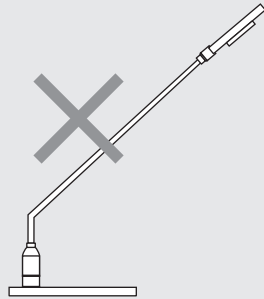

WanTeng®

WanTeng Electronic Technology Co.,Ltd

Manufacturer:
WanTeng Electronic Technology Co.,Ltd
Add: #518 C Tower,
Wenzhou Hi-tech industry Park,
wenzhou, china

Tel: +86-577-86581061,86581062

Fax: +86-577-56854770

<http://www.wantong3w.com>